

***** SCI PRODUCT CUT SHEET *****

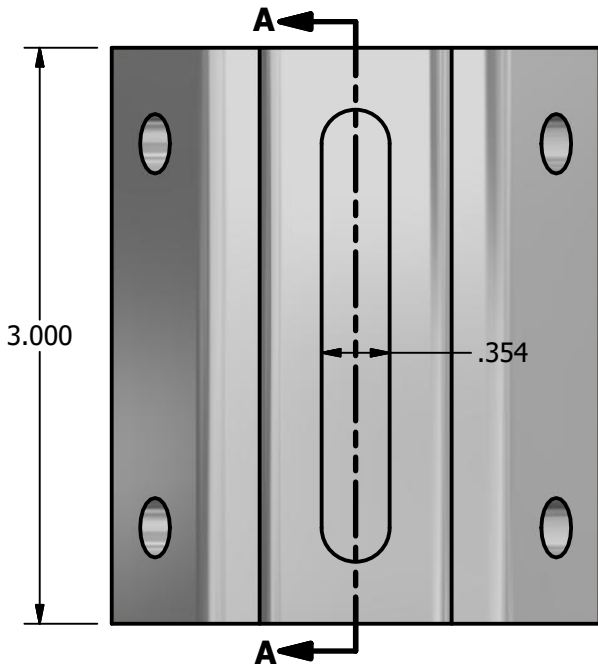

TOP VIEW

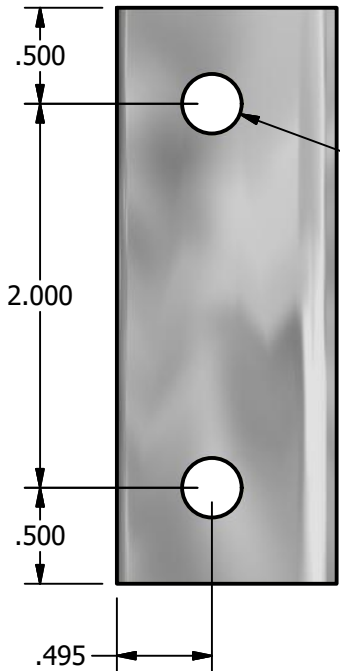

SECTION B-B

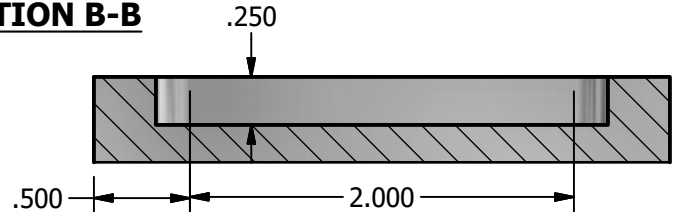
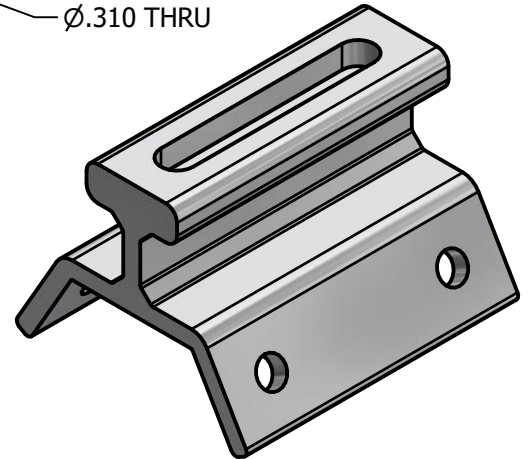

SECTION A-A

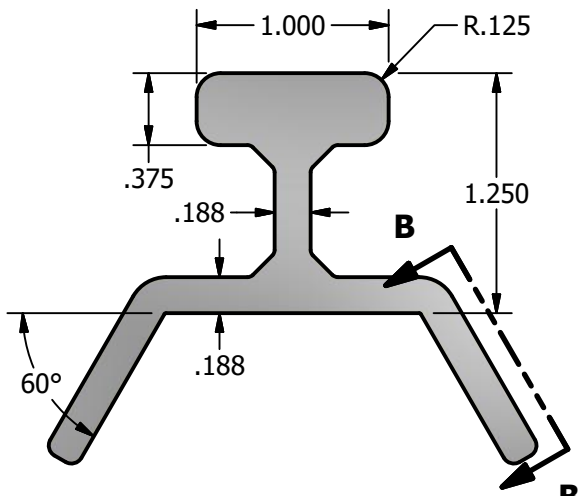

PROFILE VIEW



LEFT VIEW

NOTES:

1. FOR CLARITY THIS DRAWING IS NOT TO SCALE.
2. CONTACT THE MANUFACTURER FOR RECOMMENDED LAYOUTS, SPACING AND ADDITIONAL DETAILS.
3. INSTALLATION MUST BE COMPLETED WITH THE MANUFACTURERS WRITTEN SPECIFICATIONS AND INSTALLATION INSTRUCTIONS.
4. THESE DRAWINGS ARE SUBJECT TO CHANGE WITHOUT NOTICE.



SOLAR CONNECTIONS INTERNATIONAL

THE FUTURE OF SOLAR ATTACHMENTS

4800 METALMASTER WAY - MCHENRY, IL 60050

PHONE: 800.815.7652 WEBSITE: WWW.SOLARCONNECTIONS.COM
 FAX: 815.455.4367 E-MAIL: INFO@SOLARCONNECTIONS.COM

POWERMOUNT-6000

DRAWN BY:	rhoeffleur
DATE:	7/8/2017
SCALE:	N.T.S.
MATERIAL:	Aluminum 6061

THE INFORMATION HEREIN IS CONFIDENTIAL AND PROPRIETARY AND IS NOT TO BE DISCLOSED OR DELIVERED TO THIRD PARTIES WITHOUT THE PRIOR WRITTEN CONSENT OF SOLAR CONNECTIONS INTERNATIONAL, INC.